

PLATON NEW

Art.-Nr.

397 406
397 407
397 408

1215
1095
550
mm

1/8
vo
29-2024

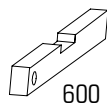
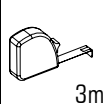
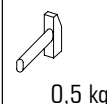
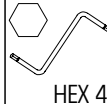
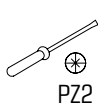
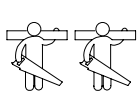

ID EE	ID	Icon	Part No.	Dimensions	Qty	Ratio
21544	②		1215*550*16	1x	1/1	
21545	③		575*413*16	1x	1/1	
21546	④		575*413*16	1x	1/1	
21547	⑤		749*548*16	1x	1/1	
21548	⑥		314*412*16	1x	1/1	
21549	⑦		1132*158*16	1x	1/1	
21550	⑧		850*136*16	1x	1/1	
21551	⑨		342*392*16	1x	1/1	
21552	⑩		342*188*16	1x	1/1	
21553	⑪		400*138*16	1x	1/1	
21554	⑫		258*138*16	1x	1/1	
21555	⑬		400*138*16	1x	1/1	
21556	⑭		406*287*3	1x	1/1	
21557	⑮		586*342*3	1x	1/1	
21558	⑯		348*414*16	1x	1/1	
21559	⑰		158*304*16	1x	1/1	
21560	⑱		325*155*16	1x	1/1	
21561	⑲		576*136*16	1x	1/1	
21562	⑳		326*628*16	1x	1/1	

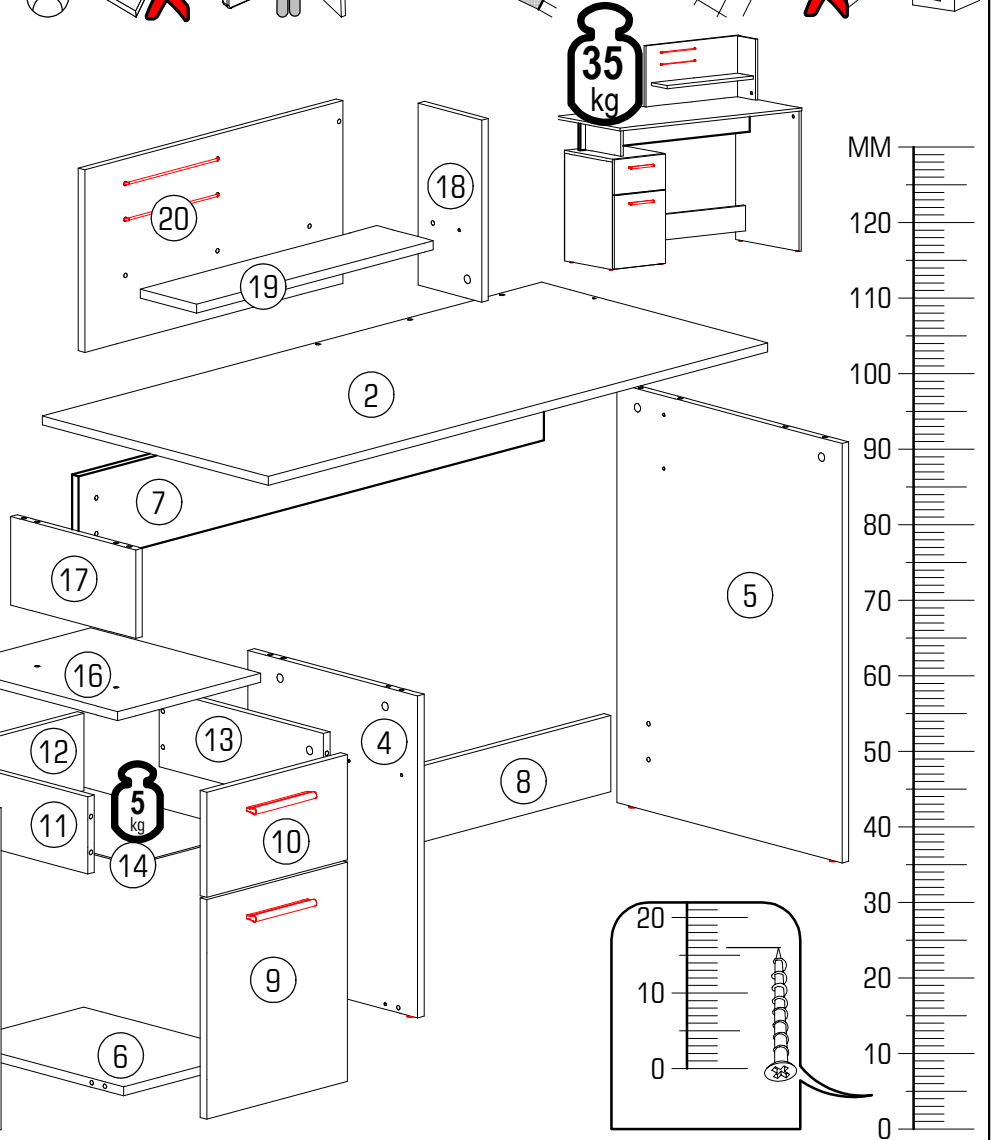
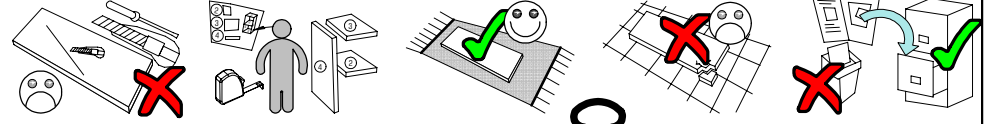

	22300.00 Ø7x50 A 20x		27000.00 B 2x		33008.00 L=400 C 13x		22243.00 Ø3,5x15 E 12x		30091.00 F 6x		50553.00 Ø1,6x20 G 25x		33008.00 L=400 H 1x		22707.00 Ø6,3x11 J 1x
	32030.00 K 2x		36002.07 L 2x		36002.07 M 2x		70021.01 P 20x		70013.01 Q 20x		35108.00 R 1x		22705.00 Ø6,8x8 S 7x		22244.01 Ø3,5x16 T 3x
	22280.00 Ø4x30 U 4x		24011.00 L=600 V 1x		24020.00 11 x 16 W 2x										

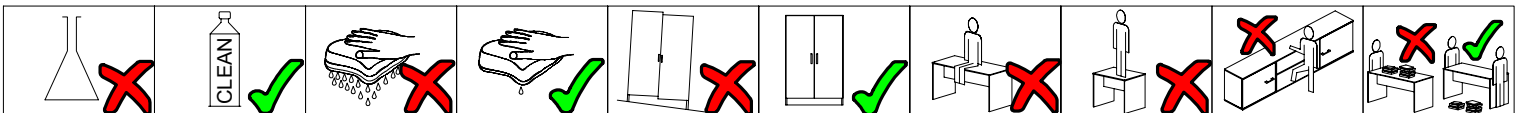

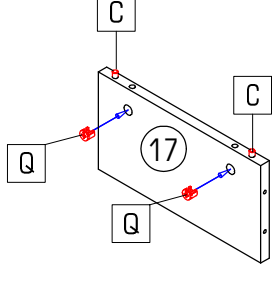
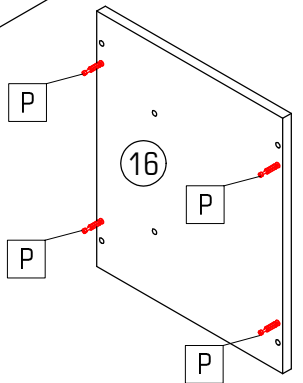
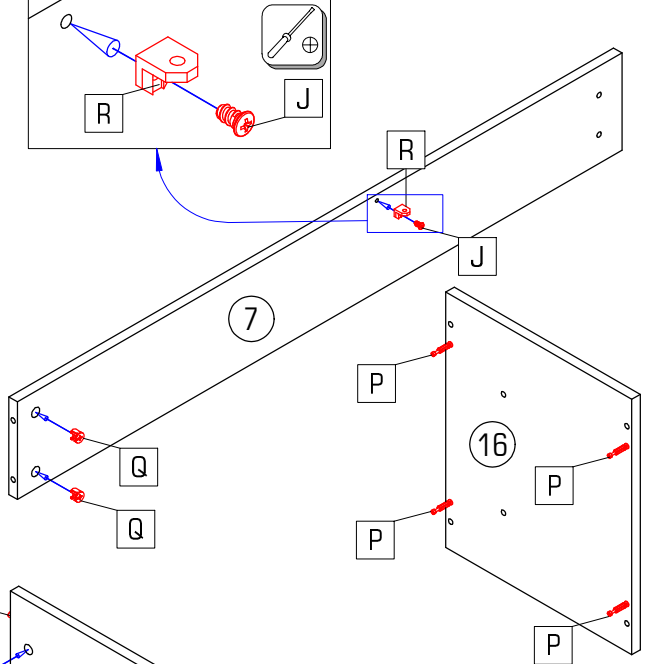
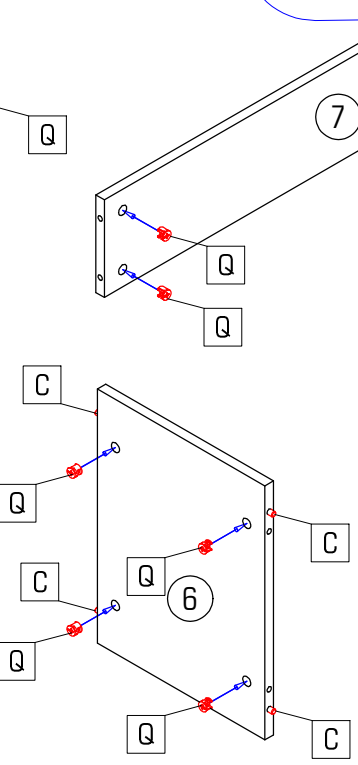
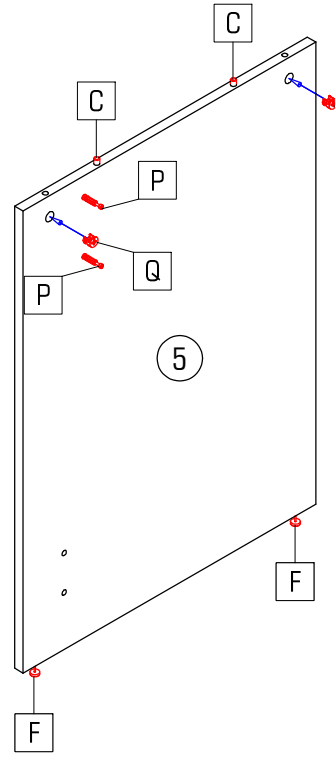
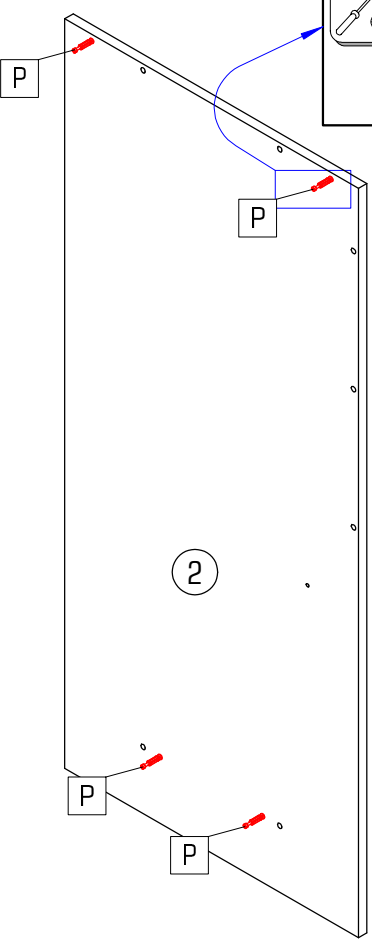
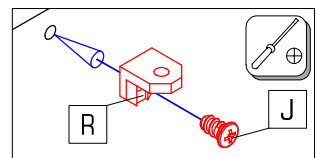
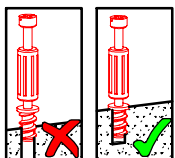
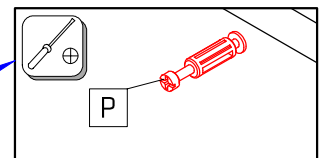
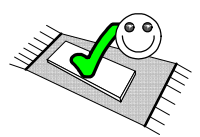
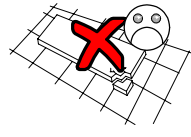
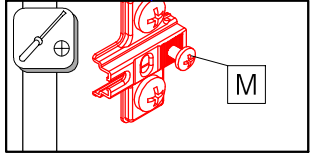
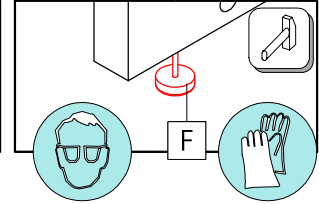
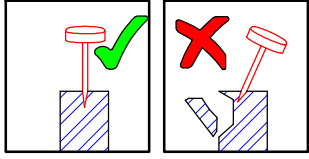
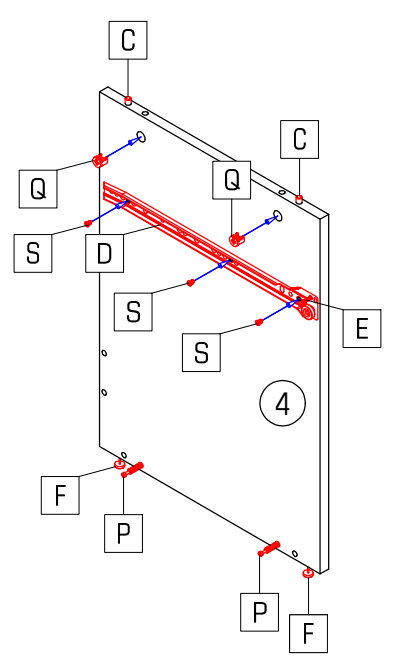
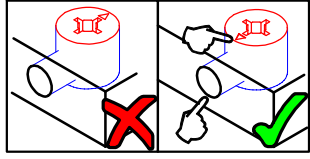
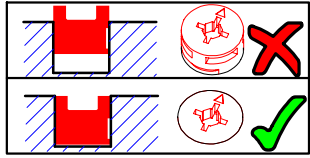
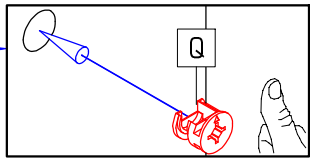
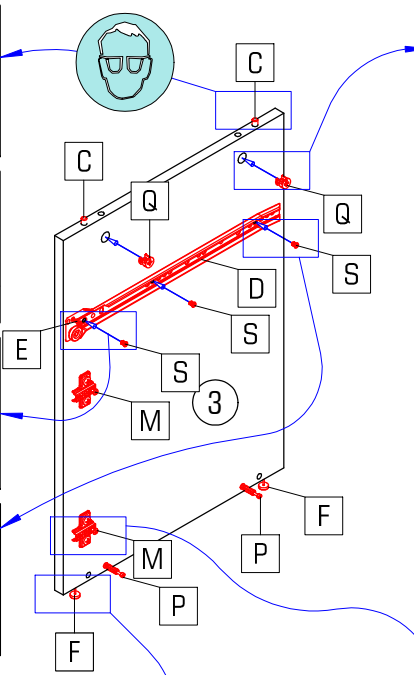
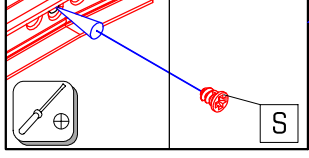
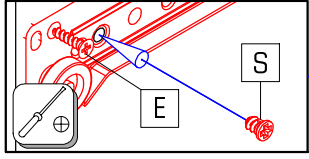
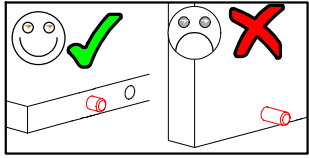
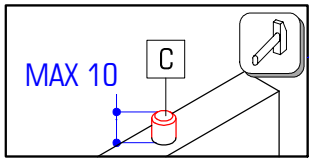

2/8 PLATON NEW

C 12x	D 1x	E 2x	F 6x	J 1x	M 2x	Q 14x	P 14x	R 1x	S 6x

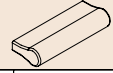
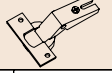
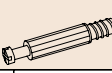
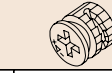

PLATON NEW 3/8

					
E 4x	K 2x	L 2x	P 4x	Q 4x	U 4x

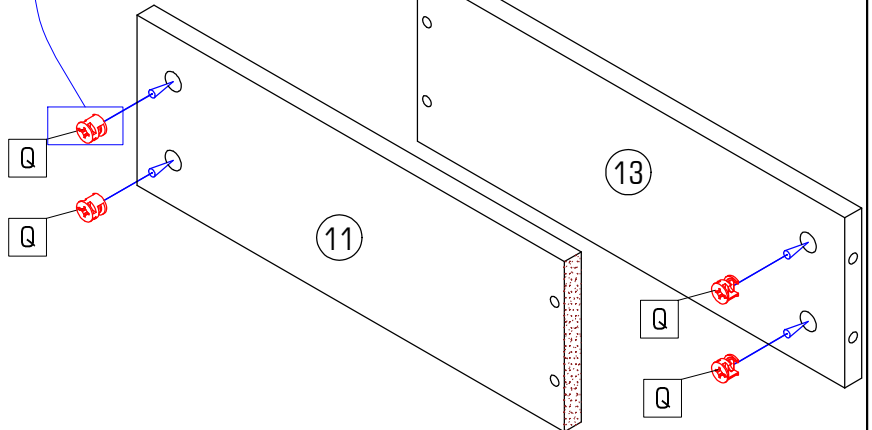
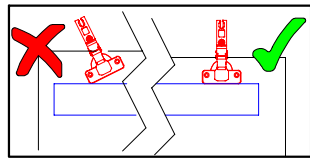
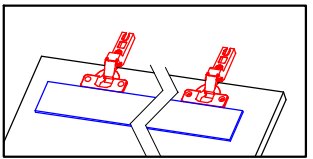
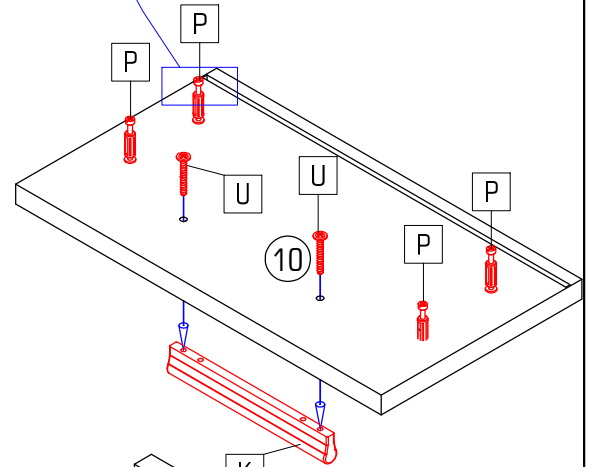
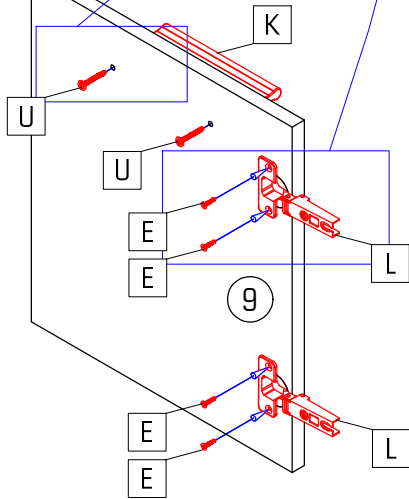
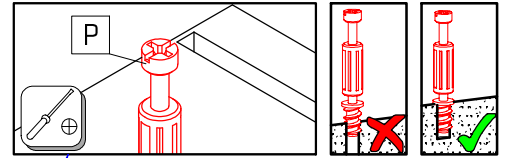
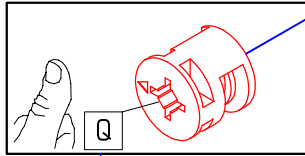
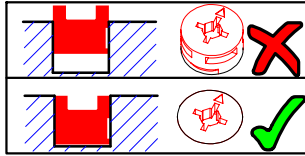
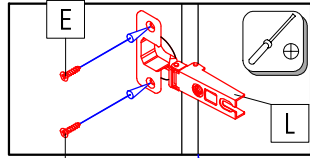
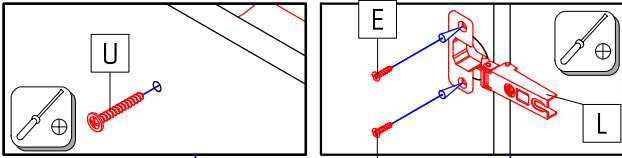

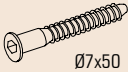

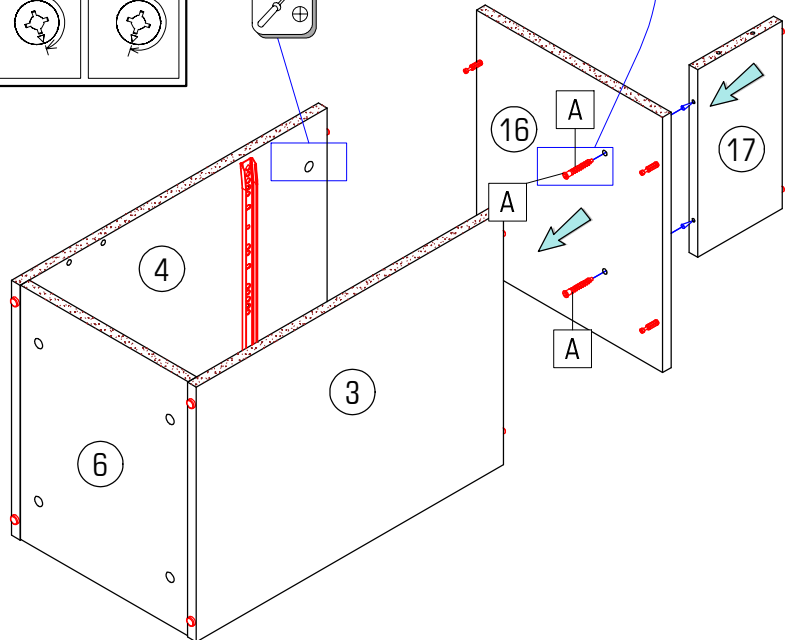
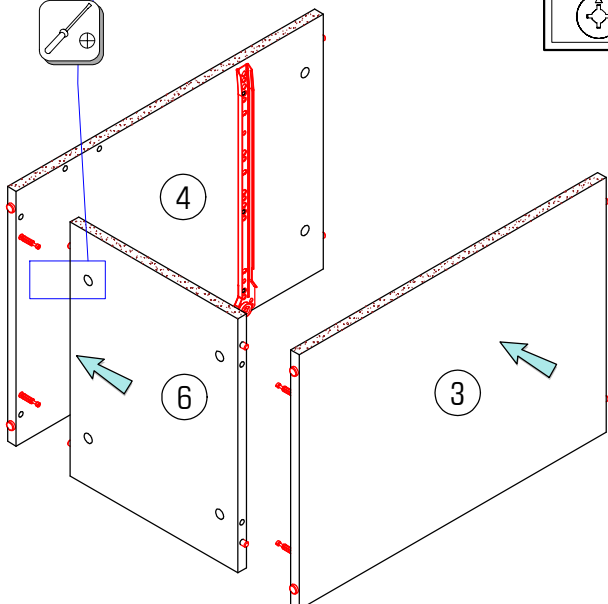
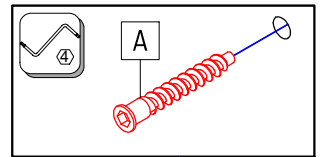
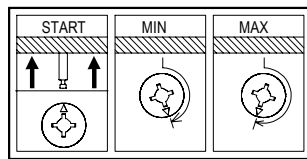
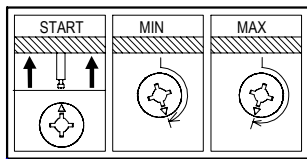

A 2x

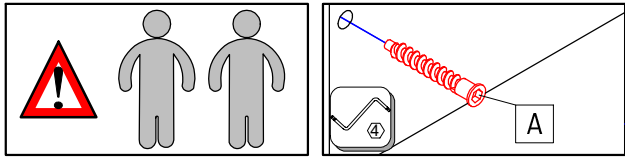
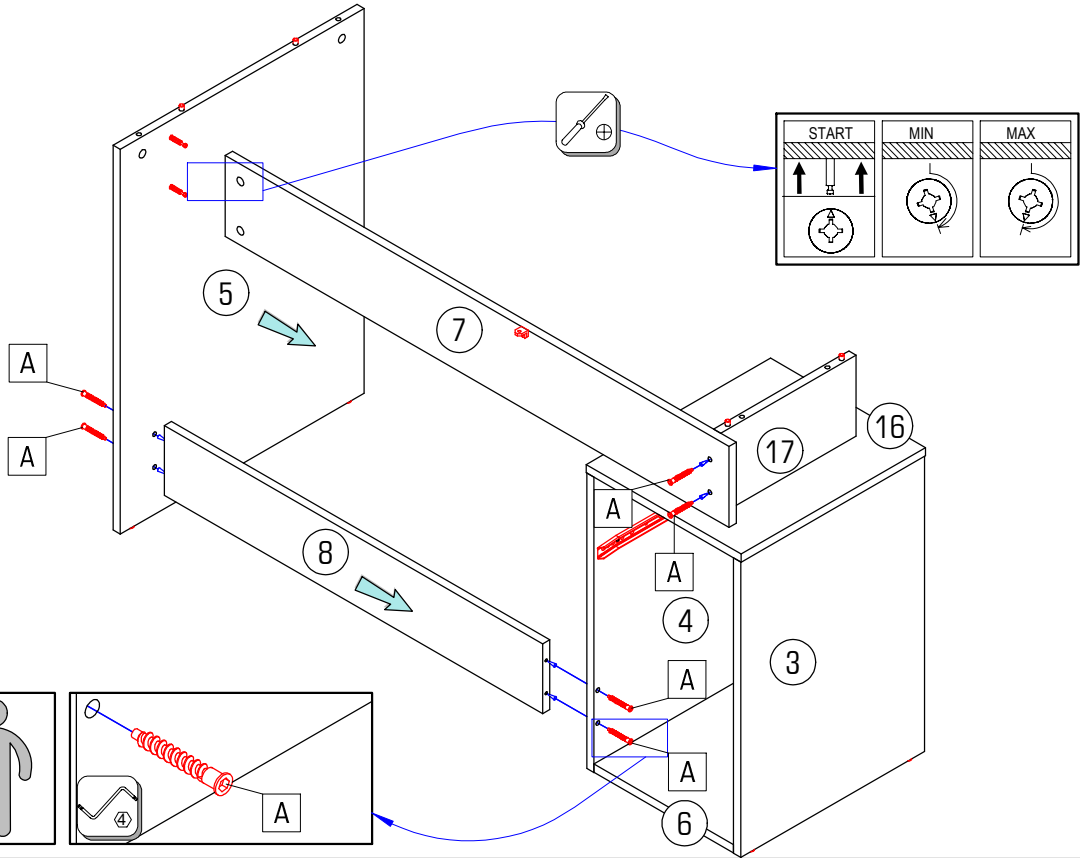

4/8 PLATON NEW



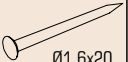

	Ø7x50
A	6x

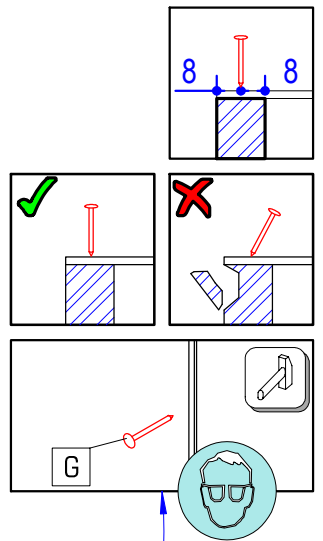
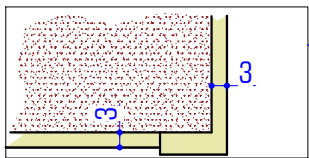
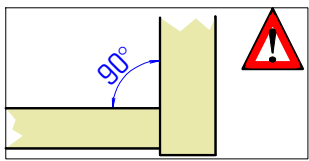
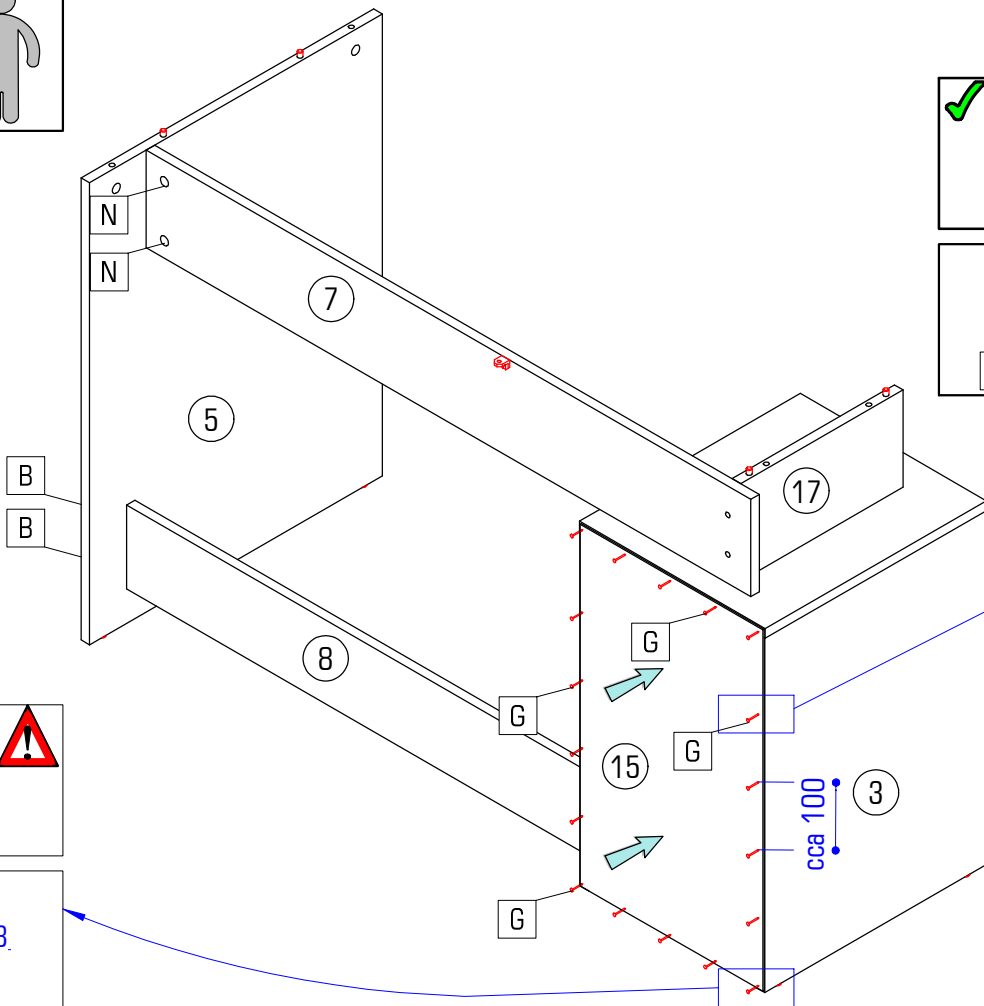
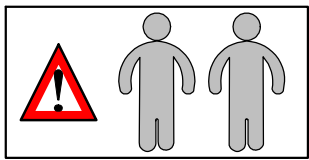

	2x		Ø1,6x20		6x
B		G	25x	N	

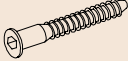

PLATON NEW 5/8



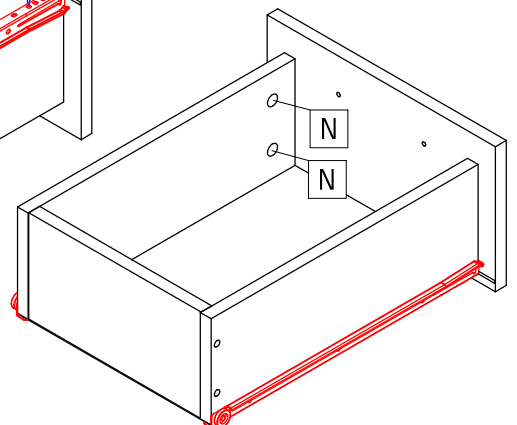
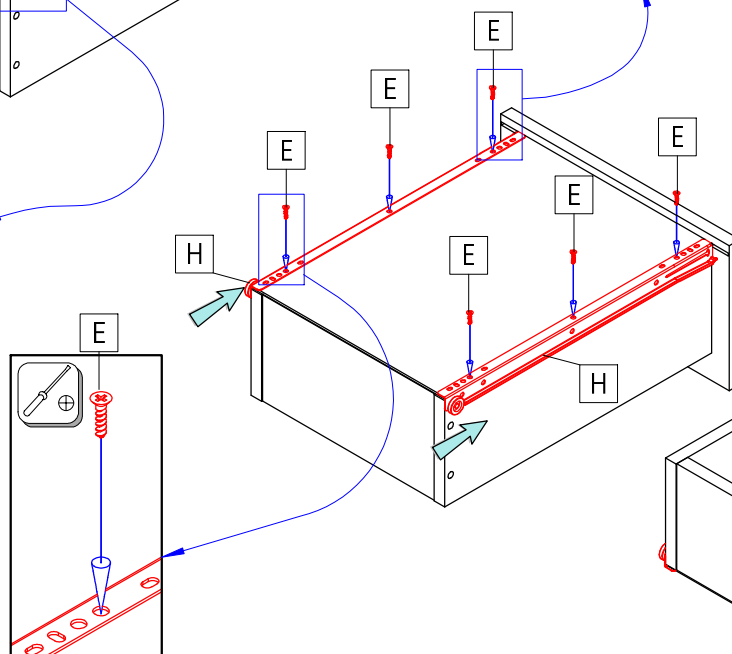
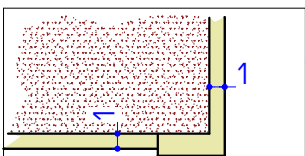
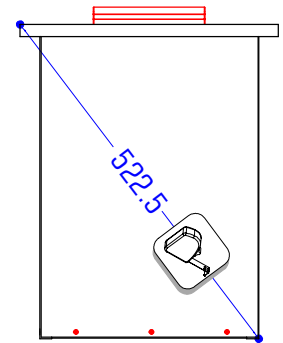
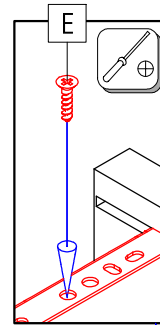
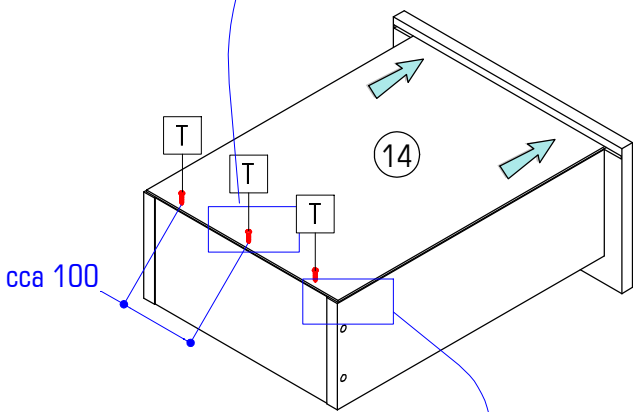
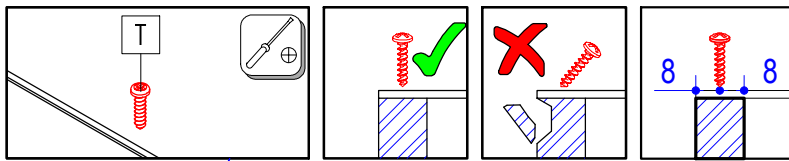
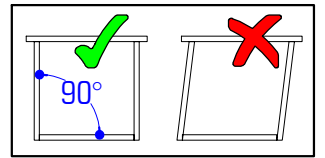
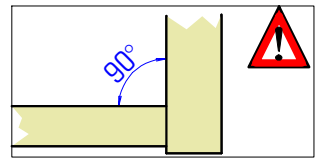
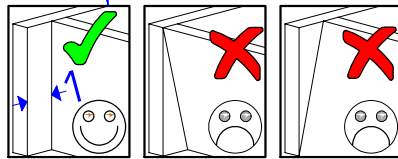
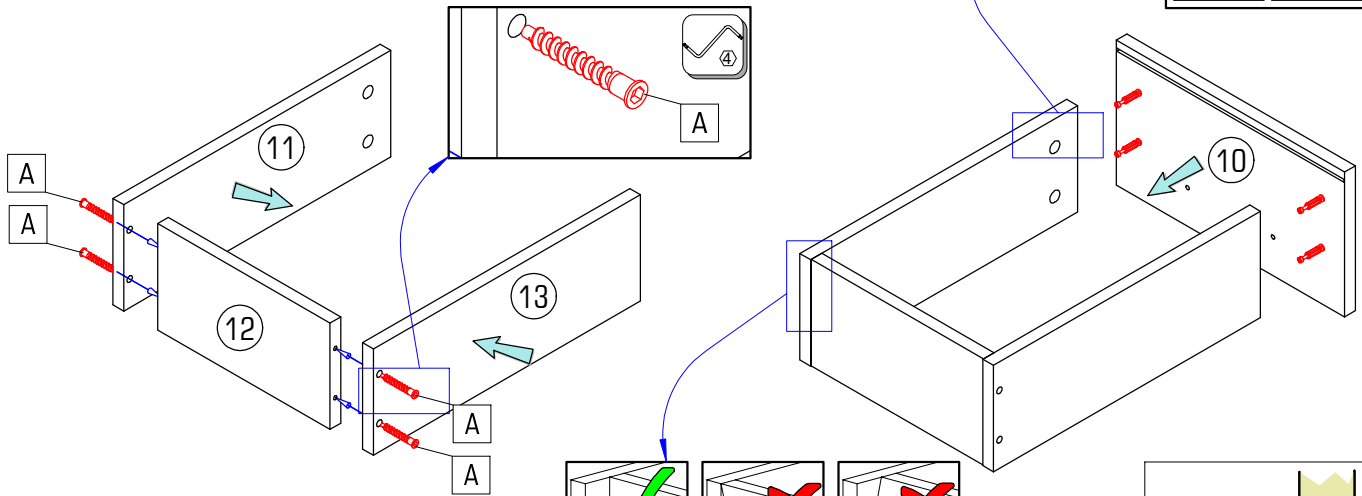
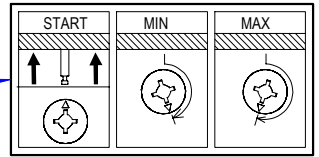

				
A	E	H	N	T
4x	6x	1x	4x	3x
	Ø3,5x15	L=350		Ø3,5x16

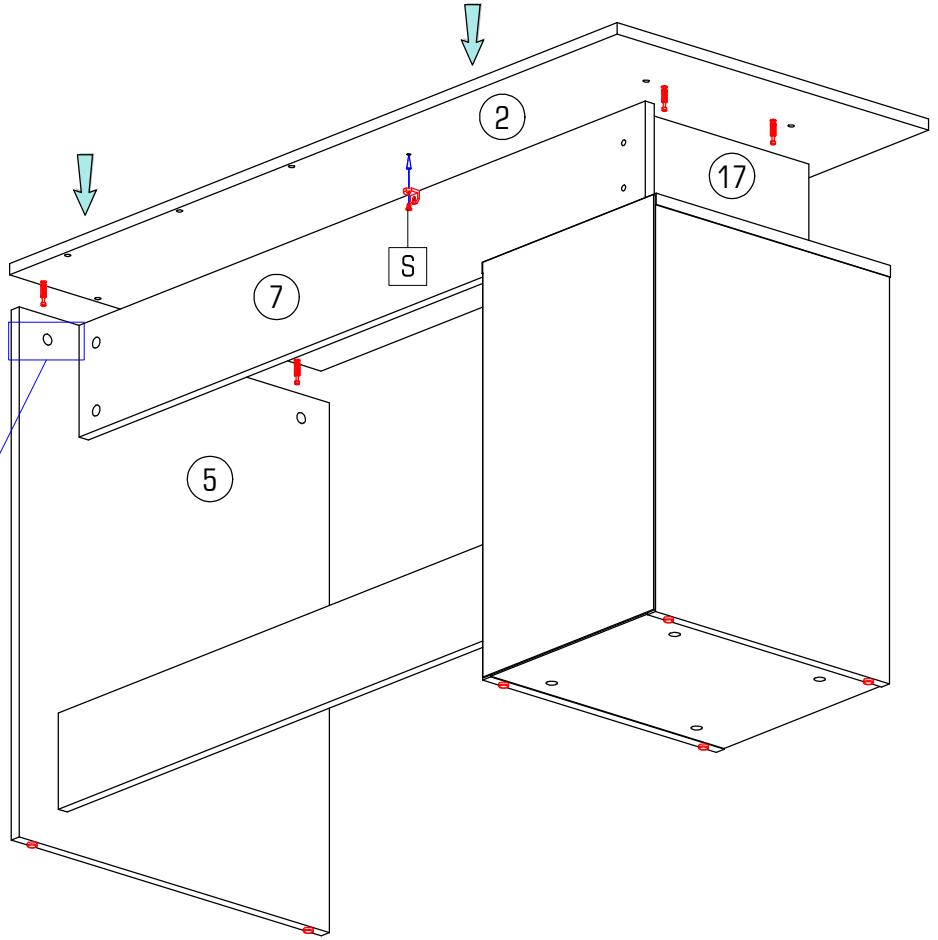
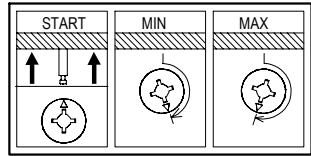

6/8 PLATON NEW

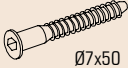
	Ø6,8x8
S	1x

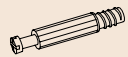

	Ø7x50			
A	5x	C	1x	P
				Q
				2x

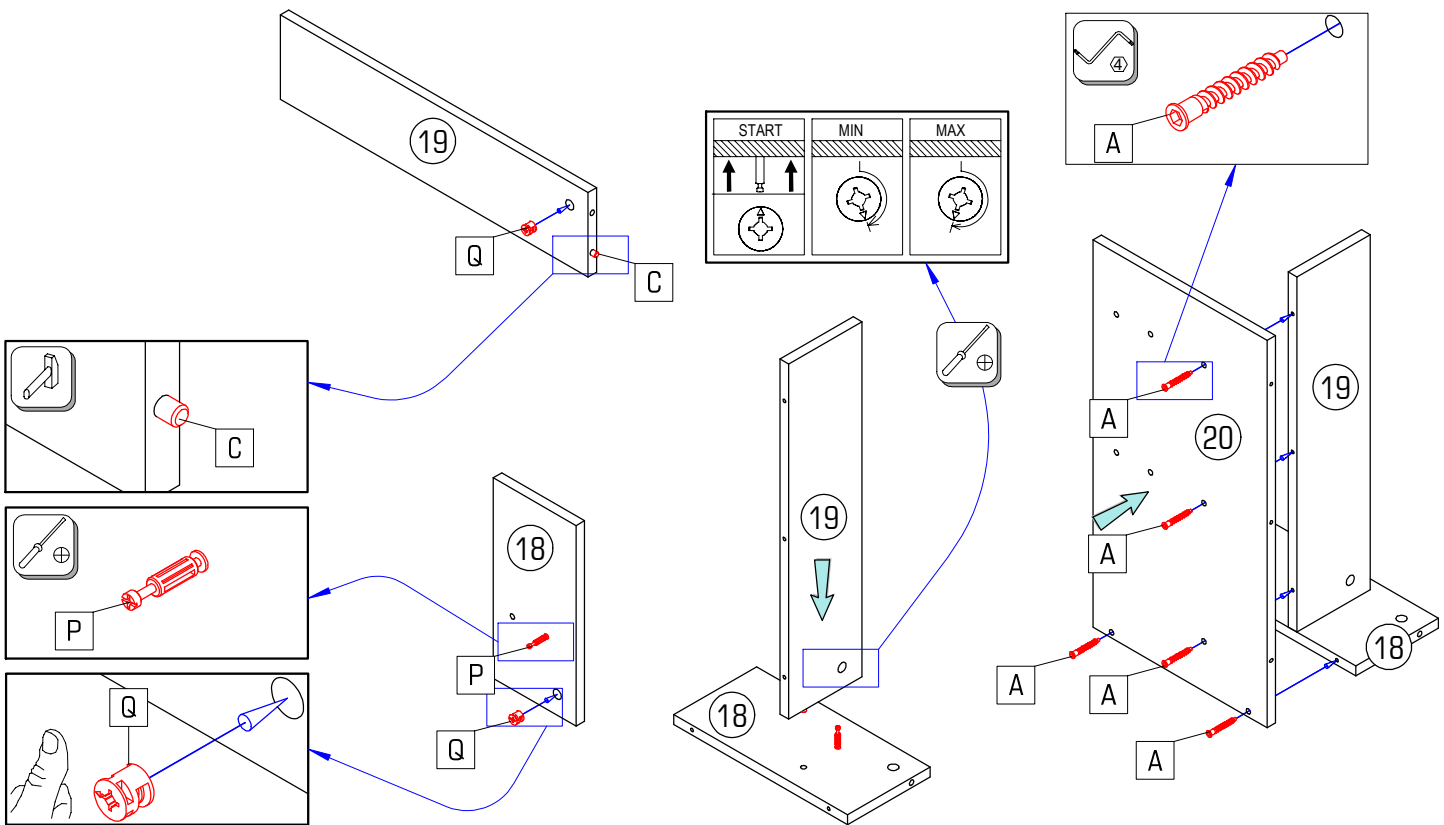

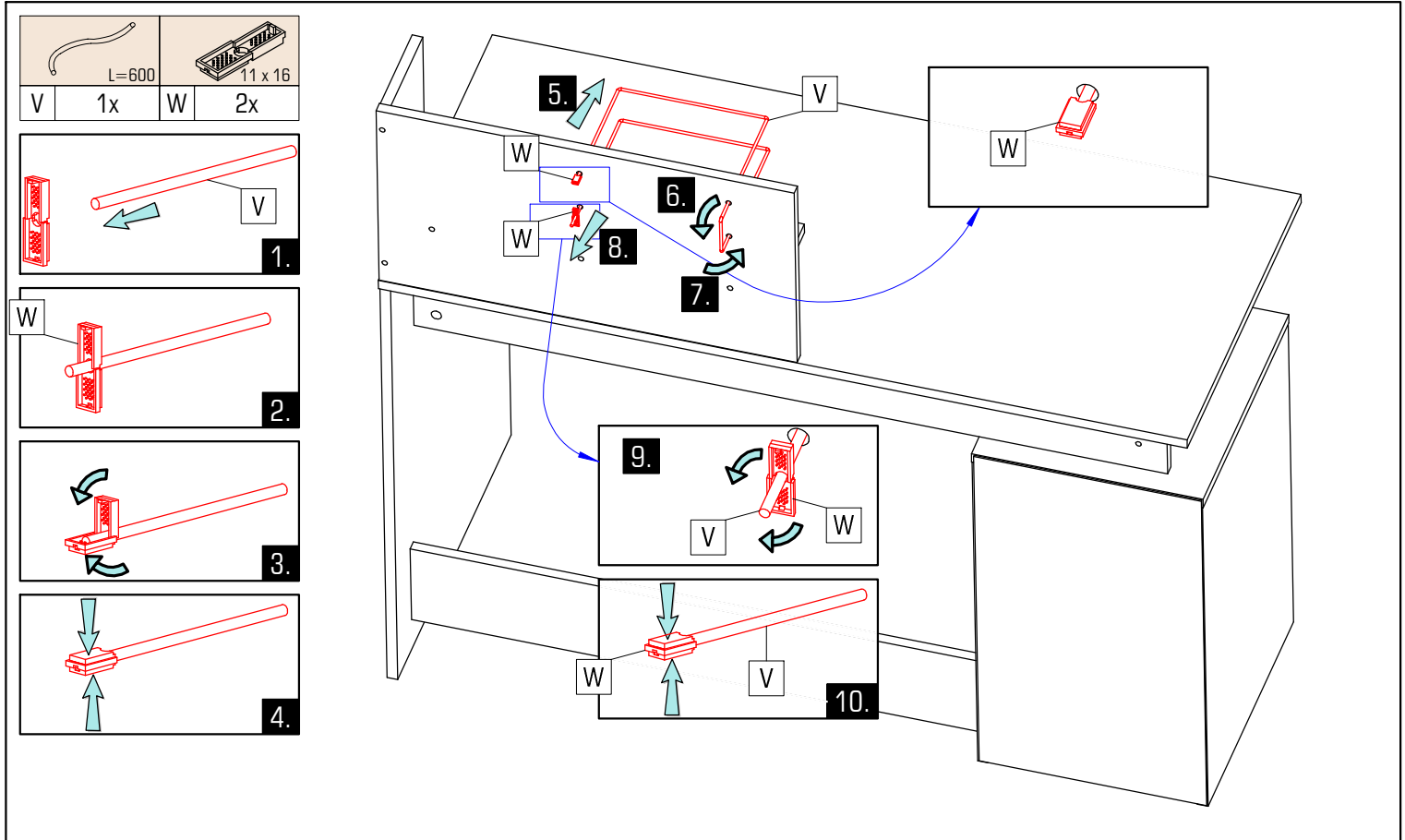
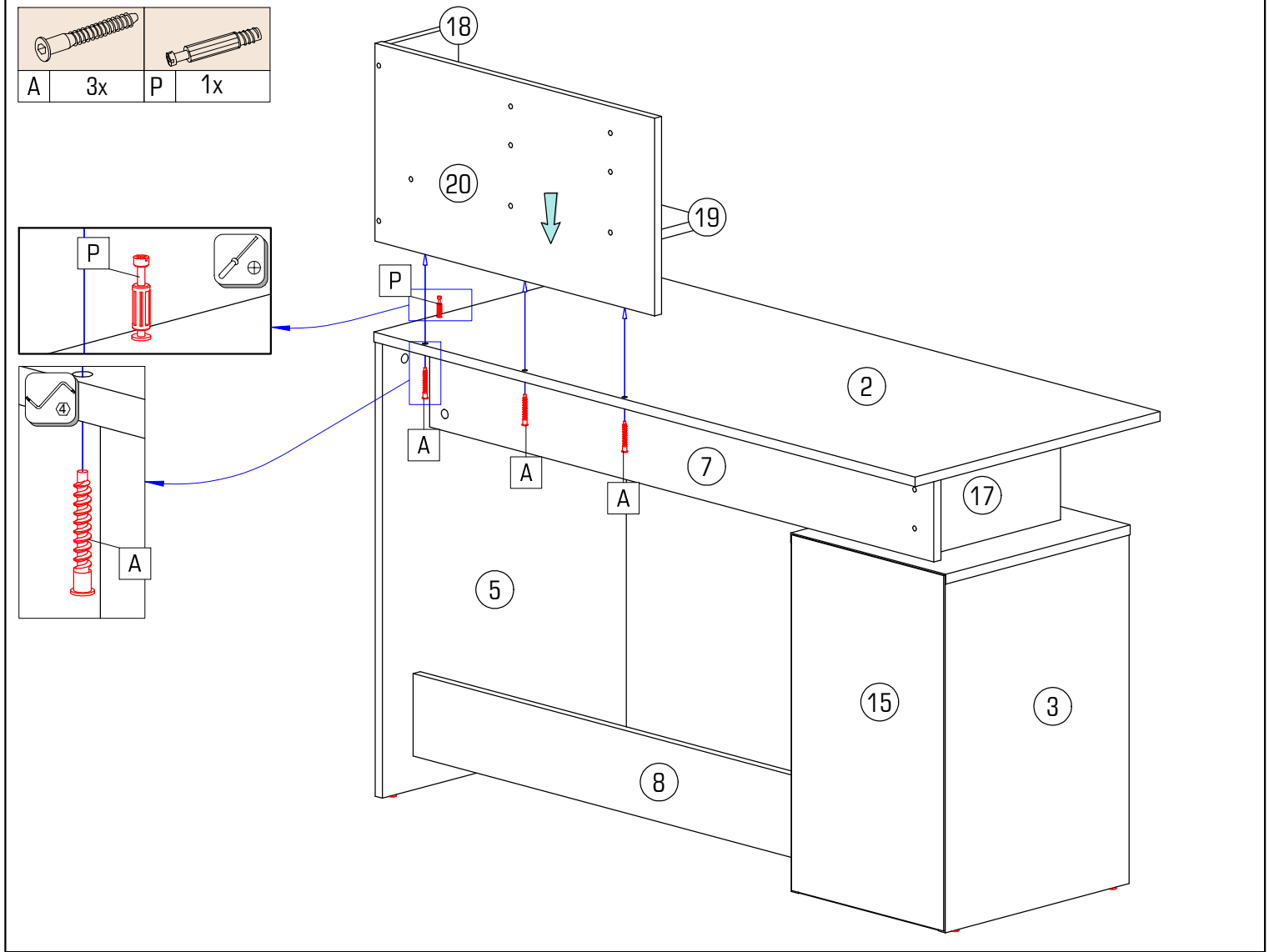

8/8 PLATON NEW

